

UHF RFID Reader



Device Spec

Dimensions	180 x 135 x 43.6 mm
Weight	500 g
Material	Die-cast aluminum
Input Voltage	DC 12~24V
Standby Current	<10mA
Work Current	1000mA +/-5% @ DC 12V Input
Operating Temp.	- 20 °C - + 65 °C
Storage Temp.	- 40 °C - + 85 °C
Humidity	5%RH - 95%RH (no condensation)
Air Protocol	EPC global UHF Class 1 Gen 2 ISO 18000-6C
Frequency	902-928MHz FCC 865-868MHz ETSI
Output Power	0 – 33dBm
Output Power Precision	± 1dB
Output Power Flatness	± 0.2dB
ReceiveSensitivity	< -80 dBm
Reading Rate	> 400 tags/s
Tag RSSI	Supported
Ambient Temp Monitor	Supported
Antenna Interface	8 Port 50Ω RF connector SMA
Host Communication	RS-232, RJ45
GPIO	2 input optical coupling 2 output coupling
Band Rate	115200 bps
Cooling Mode	Air cooling
PW/RUN LED	Red: Power on ; Blue: Reading

RTEC R3108-F

- Anti-collision Algorithm
- Fast 8-Antenna port, SMA connection
- 3 Modes for Inventory
- 18000-6C Full Compatible
- Excellent Reading Performance
- Hardware System Halt Detection
- Excellent Cooling Design
- Low-Power Design

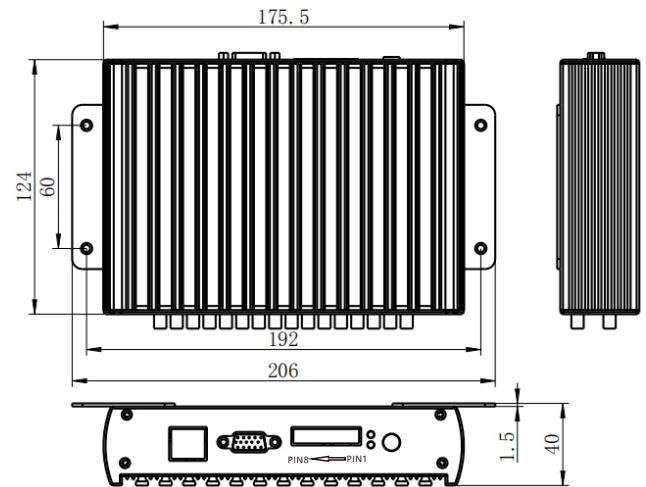

Connector Description

Connector	Description
DC12~24V	Power Input, Input Voltage: DC 12~24V; (Default: 12V/5A)
LED	Red: Power on ; Blue: Reading
12VOUT	PIN#1 DC12V Output
GND	PIN#2 Ground 【Can be GPIO Input -】
IN1	PIN#3 GPIO 1 Input +
IN2	PIN#4 GPIO 2 Input +
OUT1-1	PIN#5 relay1-NO
OUT1-2	PIN#6 relay1-COM
OUT2-1	PIN#7 relay2-NO
OUT2-2	PIN#8 relay2-COM
COM	RS232
NET	TCP/IP

Order Information

Product #	RTEC-R3108
Product Name	R3108-F Reader

RTEC Singapore

57 Mohamed Sultan Road
#01-05 Sultan Link
Singapore 238997

RTEC China

L3 Enterprise accelerator B,
Scientific innovation District, MianYang City
Sichuan, China 621000